

Link do produktu: <https://bizongarage.pl/fcst-x-fuel-cell-surge-tank-3-surge-pumps-and-1-lift-pump-included-walbro-gss342-radium-engineering-p-4161.html>

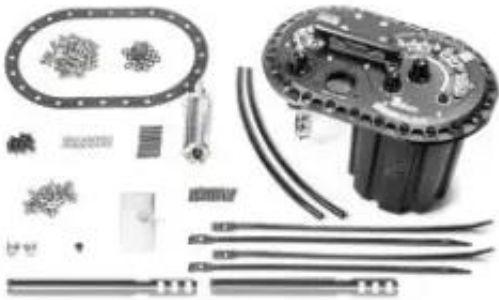

FCST-X Fuel Cell Surge Tank 3 Surge Pumps and 1 Lift Pump Included Walbro GSS342 Radium Engineering

Cena brutto	6 228,99 zł
Cena netto	5 064,22 zł
Dostępność	Na zamówienie
Numer katalogowy	331498313
Kod producenta	USA-RAD-20-1990-03

Opis produktu

LEGACY FCST FEATUREThe features listed below carry over from previous fuel cell surge tanks.-Merged single 10AN ORB female threaded outlet. All pumps use check valves that prevent back-flow.-One-way fill valves (355LPH each) allows fuel in, but not out, keeping the surge tank full.-Multiple fuel pump options including gerotor, turbine, and brushless DC motor pumps.-Hermetically sealed high-current stainless steel electrical studs capable of handling all pumps.-Simplified servicing eliminates sealing washers and fuel cell retaining brackets.-Full CNC aluminum construction with anodized surfacing for superior corrosion resistance.-Fuel compatibility: leaded and unleaded gasoline, methanol, ethanol, E85, etc.-Optional fuel surge tank level switch and diagnostic LED failsafe port.-Rollover vent valve protection **NEW FEATURES**In addition to all previous FCST features, the new FCST-X rendition is packed with innovations.-Fast lift and surge pump access (9 bolts total)-Integrated lift handle for fuel pump servicing-Lightweight surge tank increased from 2.2L to 2.6L-Compatible with up to 4 brushless fuel pumps-Up to 4 Bosch BR540 fuel pumps (DW400) -Up to 3 Ti Automotive E5LM brushless pumps-Up to 4 brushless Bosch pumps (DW440)-Compatible with 16AN inlet mechanical pumps-Easily swappable pump modules (sold separately)-Compatible with shrouded level sensors-Designed with less potential leak points-Improved fluid control for quick filling-Optimized internal fluid management-Enhanced roll over protection-Anti-rotation electrical terminals **WHAT'S IN THE BOX?**The following comes standard with every FCST-X variation-Anodized aluminum 6x10 plate-Anodized aluminum surge tank pump hat-Anodized aluminum lift pump hat-Anodized aluminum service handle-Anodized aluminum level sensor plate-Anodized aluminum surge pump bracket-Stainless lift pump mounts (shallow and deep)-Lift pump and surge pump fuel filters-Anodized aluminum 8AN roll over vent valve-FKM refueling rollover protection seal-FKM 6x10 24-hole sealing gasket-8AN ORB to 6AN male return fitting-10AN ORB to 8AN male pump out fitting-2AN ORB fuel level switch plug-FKM 1-way fill valves (x3)-Anodized aluminum acorn nuts-Electrical wire ring terminals 20-1990-00This FCST-X does not include fuel pumps. It can hold up to 3 surge tank pumps and 1 lift pump of the following. **PUMP COMPATIBILITY-** Walbro GSS342- AEM 50-1200- *Deatschwerks DW440*Use the electrical connector provided with the pumps. 20-1990-02This FCST-X is preassembled with 1 Walbro GSS342 lift pump and 2 Walbro GSS342 surge tank pumps. 20-1990-03This FCST-X is preassembled with 1 Walbro GSS342 lift pump and 3 Walbro GSS342 surge tank pumps. 20-1991-00This FCST-X does not include fuel pumps. It can hold up to 3 surge tank pumps and 1 lift pump of the following.**NOTE:** If using the optional fuel level switch inside the surge tank, only 2 surge tank pumps and 1 lift pump can be used. **PUMP COMPATIBILITY-** **Bosch BR540- *Deatschwerks DW400*Use the electrical connector provided with the pumps. For the lift pump, use the filter sock provided with the pump.**Because this pump does not include a built-in check valve, multiple surge pumps must be ran together (not staged). 20-1992-00This FCST-X does not include fuel pumps. It can hold up to 3 surge tank pumps and 1 lift pump of the following. **PUMP COMPATIBILITY-** Walbro F90000267- Walbro F90000274- Walbro F90000285- *Walbro F90000295*Because this pump does not include a built-in check valve, multiple surge pumps must be ran together (not staged). 20-1992-01This FCST-X is preassembled with 1 Walbro F90000274 lift pump and 1 Walbro F90000274 surge tank pump. 20-1992-02This FCST-X is preassembled with 1 Walbro F90000274 lift pump and 2 Walbro F90000274 surge tank pumps. 20-1992-03This FCST-X is preassembled with 1 Walbro F90000274 lift pump and 3 Walbro F90000274 surge tank pumps. 20-1993-00This FCST-X does not include fuel pumps. It can hold up to 2 surge tank pumps and 1 lift pump of the following. **SURGE PUMP COMPATIBILITY-** *Ti Automotive E5LM (check valves included)**LIFT PUMP COMPATIBILITY-** *Ti Automotive E5LM- **Walbro F90000267- **Walbro F90000274- **Walbro F90000285- **Walbro F90000295*This pump requires a brushless controller. These typically come standard when purchasing the pump. See Ti Automotive BKS1001.**For these pumps, it is recommended to use the Radium Engineering 14-0143 filter sock. 20-1995-00There are two 80u (micron) filters included for two 10AN (5/8") pickups. If using the provided 16AN (1") pickup, an external filter will need to be purchased.The surge tank can be configured to use any combination of the

following: SURGE TANK COMPATIBILITY- (1x) 10AN pickup (shown below) for an inline external pump or mechanical pump. - *(2x) 10AN pickups for an inline external pump and/or mechanical pump.- (1x) 16AN pickup for an inline external pump or mechanical pump.- *(1x) 16AN pickup and (1x) 10AN pickup (shown below) for an inline external pump and/or mechanical pump. *An electric pump can be used to prime a mechanical pump (for faster engine starting) when running 2 of the pickups.This FCST-X does not include a fuel pump for the lift pump. It is compatible with the following.LIFT PUMP COMPATIBILITY- Walbro F90000267- Walbro F90000274- Walbro F90000285- Walbro F90000295 Instruction PDF